

ALCESTIS ANTIQUÉ RUSTIC

Technical Sheet



ALCESTIS ANTIQUE RUSTIC

A new model, with particularly dynamic design. The strict, vertical lines at the headboard are being mellowed by harmonious curves.

Rustic oak wood, in warm colours, accompanied by solid metal coloured with electrostatic paint at the base of the bed, the dressing table and the bedside tables.

Overall exceptional result, with special details, meant for spaces with high aesthetics.



ALCESTIS ANTIQUE RUSTIC

bed with bedside tables

Headboard (bed)

Mdf, lined with oak, rustic oak, European ash, walnut natural veneer.

The internal structure is compact framework by chipboard and mdf.

Legs-Crossbeams

Mdf, lined with oak, rustic oak, European ash, walnut natural veneer.

Metallic solid iron, coloured with electrostatic paint at the base of the bed.

Frames-Mattress bases:

JOIN offers two types of frames:

Join Metal Frame: The frame is made of (8) rows of orthopedic slats, 163mm. wide and 8mm thick, of Spanish eucalyptus wood, covering 74% of the bed frame's free surface; the wooden slats are covered with a beech film face, ideal for special configuration and quality spring mattresses.

Upholstered with a special non slip fabric that allows the mattress to breathe.

Join Metal Frame Plus: It is made of rigid wooden boards from eucalyptus, covered with a sheet of natural cork, 185mm wide (to protect the fabric and to stop the mattress from sliding), with 15mm gaps in between for ventilation, covering 89% of the bed frame's free surface. The product is patented: Patent No1008041 and design patent: Certif. Design No: 6003514.

The standard bed dimensions are for 1,61m x 1,95m and for 1,60m x 2,00m mattresses.

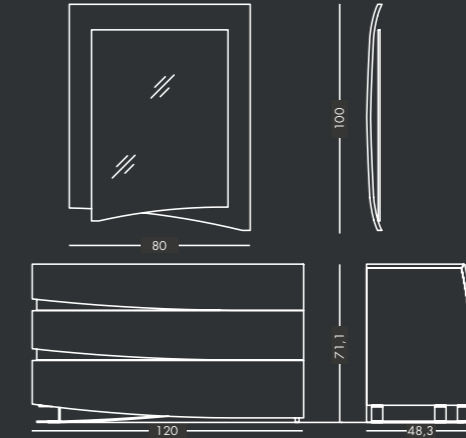
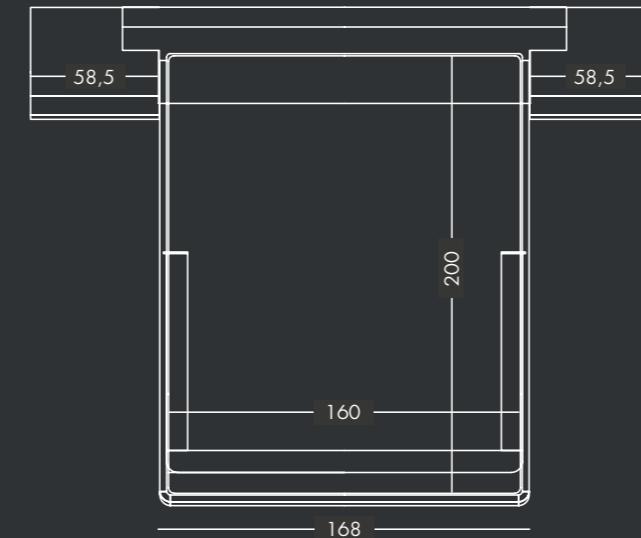
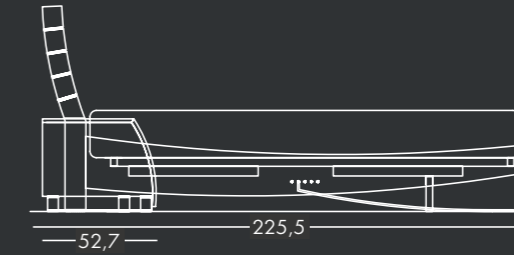
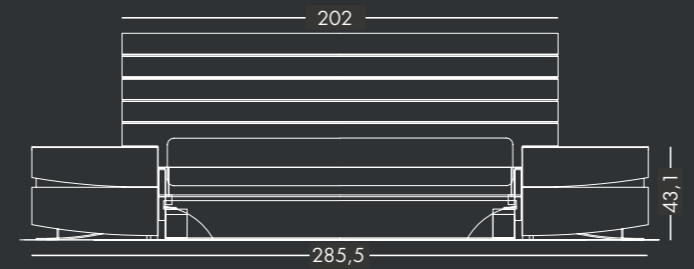

chest of drawers with mirror

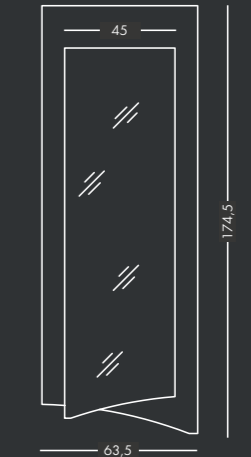

whole body wall mirror

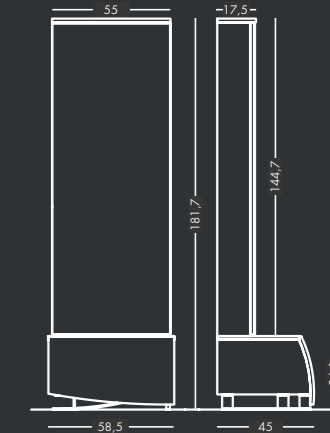

whole body mirror with storage box

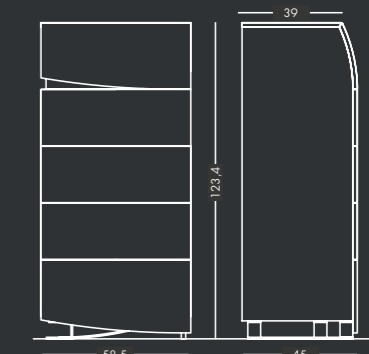

tall chest of drawers

| EXTERIOR DIMENSIONS | | | BEDSIDE TABLE | | |
|---------------------|----------|---------|---------------|---------|---------|
| Width | Length | Width | Width | Length | Height |
| 285,5 cm (total) | 225,5 cm | 95,6 cm | 58,5 cm | 52,7 cm | 43,1 cm |
| 202 cm (headboard) | | | 50 cm | | |
| 168 cm (front) | | | 45 cm | | |

ALCESTIS ANTIQUE RUSTIC

bedside table

TECHNICAL INFORMATION

The internal structure is compact framework by chipboard and mdf.

Wooden surfaces:

Mdf, lined with oak, rustic oak, European ash, walnut natural veneer.

Runner systems:

Hettich Quadro 23 SFG, load capacity up to 25 kg, certified according to ENISO 9001, guarantee of 80,000 open/close cycles.

Metallic solid iron, coloured with electrostatic paint at the base and the knob.



ALCESTIS ANTIQUE RUSTIC

chest of drawers with mirror

TECHNICAL INFORMATION

The internal structure is compact framework by chipboard and mdf.

Wooden surfaces:

Mdf, lined with oak, rustic oak, European ash, walnut natural veneer.

Runner systems:

Hettich Quadro 23 SFG, load capacity up to 25 kg, certified according to ENISO 9001, guarantee of 80,000 open/close cycles.

Metallic solid iron, coloured with electrostatic paint at the base and the knob.

The led type lighting units used at the optional equipment are produced by the German company Halemeier.

The furniture mechanisms are produced by the German company Hettich.

The varnishes applied are Milesi wood coating, environmentally friendly, with ISO14001 certification.

12/2017

* Patent design 20140600111 2,1

JOIN S.A.

A.: Orfeos 200, Egaleo

T.: 210 3413910

F.: 210 3413911

E.: info@join.gr

W.: www.join.gr

